

# HNV



## Standard couplings for industrial applications, ISO 7241-B interchange.

Standard couplings for industrial applications. Complete range of sizes from 1/8" to 2" (with BSP, NPT and SAE female threads available). ISO 7241-1 part B interchange.



## Applications

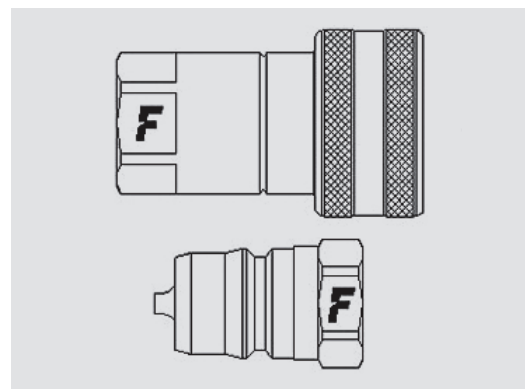

## Technical Specifications

dash	Size mm	inch	Working Pressure (MPa)	Flow Rate (l/min)	Spillage (ml)	Force to Connect (N)	Burst pressure (MPa)		
							Male	Female	Male + Female
02	3,2	1/8"	50	5	0,5	60	280	200	200
04	6,3	1/4"	45	17	1	65	180	200	180
06	10	3/8"	30	50	1,5	85	130	120	180
08	12,5	1/2"	35	75	2,8	97	140	140	150
12	20	3/4"	25	190	10	120	110	100	100
16	25	1"	30	270	13	180	120	120	120
24	37,5	1-1/2"	14	750	80	185	56	56	60
32	50	2"	9	1600	160	160	38	40	45

Material	<b>Steel</b>
Seals	<b>NBR</b>
Working temperatures	<b>- 25 °C to + 125 °C</b>
Surface treatment	<b>MATE 500 (CrIII)</b>
Series Interchange	<b>ISO 7241-B</b>
Valve Type	<b>Poppet</b>
Connection	<b>Sleeve Retraction</b>
Disconnection	<b>Sleeve Retraction</b>
Connection Under Pressure	<b>Not Allowed</b>

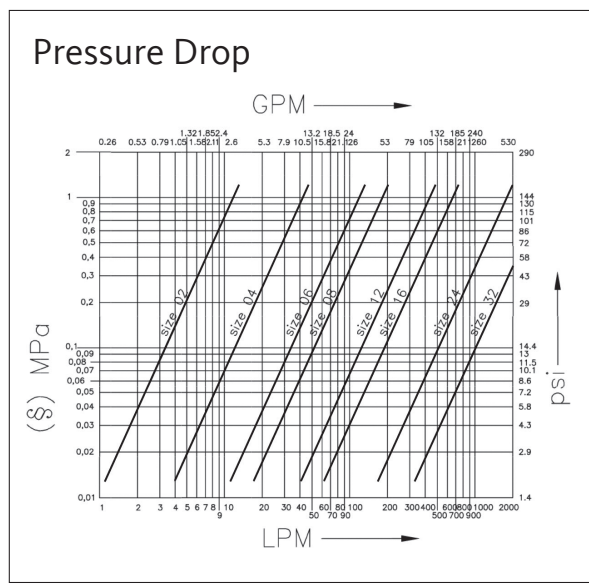

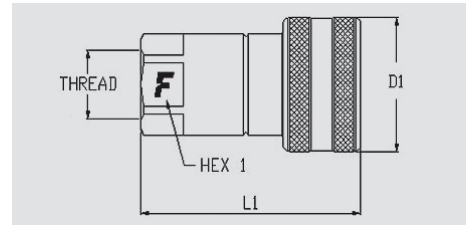

Size		Thread details			FEMALE						
inch	mm	Thread Type	Standard	Thread	Part Number	L (L1 + Thread)		D1		HEX1	
						mm	inch	mm	inch	mm	inch
1/8"	3,2	F BSPP	ISO 1179-1	BSPP 1/8 FEMALE	HNV 18 GAS F	50,3	1,98	23	0,91	18	0,71
1/8"	3,2	F NPTF	ANSI B1.20.3	NPTF 1/8 FEMALE	HNV 18 NPT F	50,3	1,98	23	0,91	18	0,71
1/4"	6,3	O/ SAE	ISO 11926-1	9/16"-18 UNF FEMALE ORB	HNV 14-38SAE F	60	2,36	28	1,1	19	0,75
1/4"	6,3	F BSPP	ISO 1179-1	BSPP 1/4 FEMALE	HNV 14 GAS F	56	2,2	28	1,1	19	0,75
1/4"	6,3	F NPTF	ANSI B1.20.3	NPTF 1/4 FEMALE	HNV 14 NPT F	56	2,2	28	1,1	19	0,75
3/8"	10	O/ SAE	ISO 11926-1	9/16"-18 UNF FEMALE ORB	HNV 38-38SAE F	64	2,52	35	1,38	24	0,94
3/8"	10	F BSPP	ISO 1179-1	BSPP 3/8 FEMALE	HNV 38 GAS F	64	2,52	35	1,38	24	0,94
3/8"	10	F NPTF	ANSI B1.20.3	NPTF 3/8 FEMALE	HNV 38 NPT F	64	2,52	35	1,38	24	0,94
3/8"	10	F NPTF	ANSI B1.20.3	NPTF 3/8 FEMALE	HNV 38 NPT F N	64	2,52	35	1,38	24	0,94
1/2"	12,5	O/ SAE	ISO 11926-1	7/8"-14 UNF FEMALE ORB	HNV 12-58SAE F	71,5	2,81	44	1,73	30	1,18
1/2"	12,5	F BSPP	ISO 1179-1	BSPP 1/2 FEMALE	HNV 12 GAS F	71,5	2,81	44	1,73	30	1,18
1/2"	12,5	F BSPP	ISO 1179-1	BSPP 1/2 FEMALE	HNV 12 GAS F V	71,5	2,81	44	1,73	30	1,18
1/2"	12,5	F NPTF	ANSI B1.20.3	NPTF 1/2 FEMALE	HNV 12 NPT F	71,5	2,81	44	1,73	30	1,18
3/4"	20	O/ SAE	ISO 11926-1	1-1/16"-12 UN FEMALE ORB	HNV 34-34SAE F	89	3,5	52	2,05	36	1,42
3/4"	20	12/ SAE	ISO 8434-3	1-3/16"-12 UN MALE BULKHEAD ORFS	HNV 34-12/34SF	146	5,75	52	2,05	36	1,42
3/4"	20	F BSPP	ISO 1179-1	BSPP 3/4 FEMALE	HNV 34 GAS F	89	3,5	52	2,05	36	1,42
3/4"	20	F NPTF	ANSI B1.20.3	NPTF 3/4 FEMALE	HNV 34 NPT F	89	3,5	52	2,05	36	1,42
1"	25	O/ SAE	ISO 11926-1	1-5/16"-12 UN FEMALE ORB	HNV 1-1SAE F	106	4,17	62	2,44	41	1,61
1"	25	F BSPP	ISO 1179-1	BSPP 1 FEMALE	HNV 1 GAS F	106	4,17	62	2,44	41	1,61
1"	25	F NPTF	ANSI B1.20.3	NPTF 1 FEMALE	HNV 1 NPT F	106	4,17	62	2,44	41	1,61
1-1/2"	37,5	F BSPP	ISO 1179-1	BSPP 1-1/2 FEMALE	HNV112 GAS F	126,4	4,98	75	2,95	65	2,56
1-1/2"	37,5	F BSPP	ISO 1179-1	BSPP 1-1/4 FEMALE	HNV112-114GAS F	126	4,96	75	2,95	65	2,56
2"	50	F NPTF	ANSI B1.20.3	NPTF 2 FEMALE	HNV 2 NPT F	142	5,59	105	4,13	89	3,5

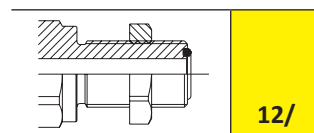
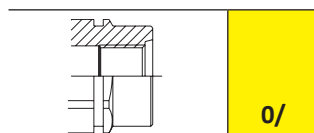
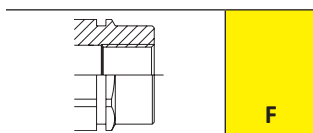

HNV

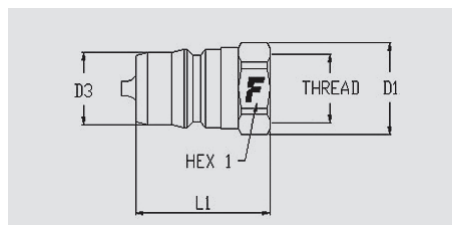

Size		Thread details			MALE									
inch	mm	Thread Type	Standard	Thread	Part Number	L (L1 + Thread)		D1		D3		HEX1		
						mm	inch	mm	inch	mm	inch	mm	inch	
1/8"	3,2	F BSPP	ISO 1179-1	BSPP 1/8 FEMALE	HNV 18 GAS M	31,5	1,24	18,5	0,73	10,8	0,43	17	0,67	
1/8"	3,2	F NPTF	ANSI B1.20.3	NPTF 1/8 FEMALE	HNV 18 NPT M	31,5	1,24	19	0,75	10,8	0,43	17	0,67	
1/4"	6,3	O/ SAE	ISO 11926-1	9/16"-18 UNF FEMALE ORB	HNV 14-38SAE M	39	1,54	21	0,83	14,1	0,56	19	0,75	
1/4"	6,3	F BSPP	ISO 1179-1	BSPP 1/4 FEMALE	HNV 14 GAS M	35	1,38	21	0,83	14,1	0,56	19	0,75	
1/4"	6,3	F NPTF	ANSI B1.20.3	NPTF 1/4 FEMALE	HNV 14 NPT M	35	1,38	21	0,83	14,1	0,56	19	0,75	
3/8"	10	O/ SAE	ISO 11926-1	3/4"-16 UNF FEMALE ORB	HNV 38-12SAE M	45	1,77	30	1,18	19	0,75	27	1,06	
3/8"	10	O/ SAE	ISO 11926-1	9/16"-18 UNF FEMALE ORB	HNV 38-38SAE M	39	1,54	24,5	0,96	19	0,75	22	0,87	
3/8"	10	F BSPP	ISO 1179-1	BSPP 3/8 FEMALE	HNV 38 GAS M	39	1,54	24,5	0,96	19	0,75	22	0,87	
3/8"	10	F NPTF	ANSI B1.20.3	NPTF 3/8 FEMALE	HNV 38 NPT M	39	1,54	24,5	0,96	19	0,75	22	0,87	
3/8"	10	F NPTF	ANSI B1.20.3	NPTF 3/8 FEMALE	HNV 38 NPT M N	39	1,54	24,5	0,96	19	0,75	22	0,87	
1/2"	12,5	O/ SAE	ISO 11926-1	3/4"-16 UNF FEMALE ORB	HNV 12-12SAE M	44	1,73	30	1,18	23,5	0,93	27	1,06	
1/2"	12,5	O/ SAE	ISO 11926-1	7/8"-14 UNF FEMALE ORB	HNV 12-58SAE M	50	1,97	33	1,3	23,5	0,93	30	1,18	
1/2"	12,5	F BSPP	ISO 1179-1	BSPP 1/2 FEMALE	HNV 12 GAS M	44	1,73	30	1,18	23,5	0,93	27	1,06	
1/2"	12,5	F NPTF	ANSI B1.20.3	NPTF 1/2 FEMALE	HNV 12 NPT M	44	1,73	30	1,18	23,5	0,93	27	1,06	
3/4"	20	O/ SAE	ISO 11926-1	1-1/16"-12 UN FEMALE ORB	HNV 34-34SAE M	55	2,17	38	1,5	31,5	1,24	34	1,34	
3/4"	20	F BSPP	ISO 1179-1	BSPP 3/4 FEMALE	HNV 34 GAS M	55	2,17	38	1,5	31,5	1,24	34	1,34	
3/4"	20	F NPTF	ANSI B1.20.3	NPTF 3/4 FEMALE	HNV 34 NPT M	55	2,17	38	1,5	31,5	1,24	34	1,34	
1"	25	O/ SAE	ISO 11926-1	1-5/16"-12 UN FEMALE ORB	HNV 1- 1SAE M	66	2,6	45	1,77	37,8	1,49	41	1,61	
1"	25	F BSPP	ISO 1179-1	BSPP 1 FEMALE	HNV 1 GAS M	66	2,6	45	1,77	37,8	1,49	41	1,61	
1"	25	F NPTF	ANSI B1.20.3	NPTF 1 FEMALE	HNV 1 NPT M	66	2,6	45	1,77	37,8	1,49	41	1,61	
1-1/2"	37,5	F BSPP	ISO 1179-1	BSPP 1-1/2 FEMALE	HNV112 GAS M	126	4,96	71	2,8	44,5	1,75	65	2,56	
1-1/2"	37,5	F BSPP	ISO 1179-1	BSPP 1-1/4 FEMALE	HNV112-114GAS M	126	4,96	71	2,8	44,5	1,75	65	2,56	
2"	50	F NPTF	ANSI B1.20.3	NPTF 2 FEMALE	HNV 2 NPT M	142	5,59	97	3,82	63,25	2,49	89	3,5	

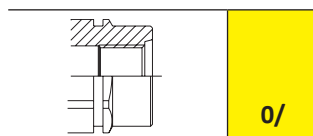
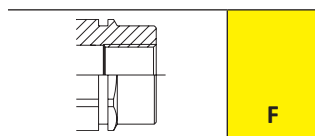

# HNV Accessories

## PVC dust caps



**Plugs suitable for FEMALE**



**Caps suitable for MALE**

Size			Plug Details		Size			Cap Details	
inch	mm	dash	Part number	Colour	inch	mm	dash	Part number	Colour
1/8"	3,2	02	TMH 18	red	1/8"	3,2	02	TFH 18	red
1/4"	6,3	04	TMH 14	red	1/4"	6,3	04	TFH 14	red
1/4"	6,3	04	TMH 14 N	black	1/4"	6,3	04	TFH 14 N	black
3/8"	10	06	TMH 38	red	3/8"	10	06	TFH 38	red
3/8"	10	06	TMH 38 A	orange	3/8"	10	06	TFH 38 A	orange
3/8"	10	06	TMH 38 B	blue	3/8"	10	06	TFH 38 B	blue
3/8"	10	06	TMH 38 G	yellow	3/8"	10	06	TFH 38 G	yellow
1/2"	12,5	08	TMH 12	red	3/8"	10	06	TFH 38 N	black
3/4"	20	12	TMH 34	red	1/2"	12,5	08	TFH 12	red
3/4"	20	12	TMH 34 N	black	3/4"	20	12	TFH 34	red
1"	25	16	TMH 1	red	3/4"	20	12	TFH 34 N	black
					1"	25	16	TFH 1	red

## Aluminium dust caps



**Plugs suitable for FEMALE**



**Caps suitable for MALE**

Size			Plug Details		Size			Cap Details	
inch	mm	dash	Part number	Colour	inch	mm	dash	Part number	Colour
1/8"	3,2	02	TMH 18 S		1/8"	3,2	02	TFH 18 S	
1/4"	6,3	04	TMH 14 S		1/4"	6,3	04	TFH 14 S	
3/8"	10	06	TMH 38 S		1-1/2"	37,5	24	TFH112 S	
1-1/2"	37,5	24	TMH112 S		2"	50	32	TFH 2 S	
2"	50	32	TMH 2 S						

## Seal Kits



### For Female

Size			Seal Details	
inch	mm	dash	Material	Part Number
1/8"	3,2	02	NBR; PTFE	SK HNV 18
1/8"	3,2	02	FKM; PTFE	SK HNV 18 V
1/4"	6,3	04	NBR; PTFE	SK HNV 14
1/4"	6,3	04	FKM; PTFE	SK HNV 14 V
3/8"	10	06	NBR; PTFE	SK HNV 38
3/8"	10	06	FKM; PTFE	SK HNV 38 V
1/2"	12,5	08	NBR; PTFE	SK HNV 12
1/2"	12,5	08	NBR; PTFE	SK HNV 12 V
3/4"	20	12	NBR; PTFE	SK HNV 34
3/4"	20	12	FKM; PTFE	SK HNV 34 V
1"	25	16	NBR; PTFE	SK HNV 1
1"	25	16	FKM; PTFE	SK HNV 1 V
1-1/2"	37,5	24	NBR	SK HNV 112
1-1/2"	37,5	24	FKM	SK HNV 112 V
2"	50	32	NBR	SK HNV 2
2"	50	32	FKM	SK HNV 2 V

Every seals kit is composed of 5 or 10 pcs.