

Valvola elettrica 2 vie, diretta, normalmente chiusa
2 way, direct operated electric valve, normally closed

Rev.02-2016/03

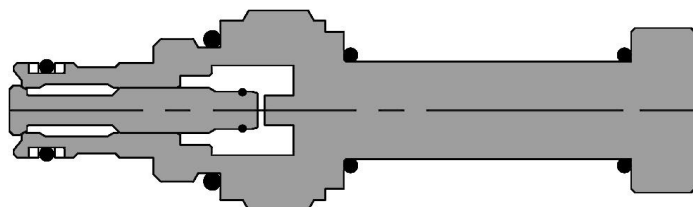
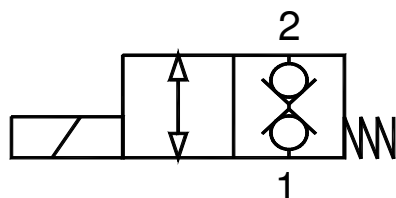

SPECIFICHE TECNICHE

Materiali: cartuccia in acciaio zincato. Componenti interni in acciaio trattato termicamente.
Campo di portata: 15 L/min;
Pressione max.: 310 bar (Bobina 20 W)
Coppia di serraggio in cavità: vedere pag.2
Cavità: vedere sezione X
Peso cartuccia: vedere pagina 2
Bobine: versione C-13, vedere sezione Y
Temperatura olio: -20°C + 80°C
Temperatura ambiente: -30°C + 60°C
Filtrazione consigliata: nominale max. 10µ, ISO 4406-19/17/14 (NAS8) o minore
 La variazione di voltaggio in ingresso non deve eccedere il ±10% del valore nominale.

TECHNICAL SPECIFICATIONS

Materials: cartridge in steel zinc plated, internal parts in hardened steel.
Flow range: 15 L/min;
Max. pressure: 310 bar (Coil 20 W)
Installation torque: see page 2
Cavity: see section X
Cartridge weight: see page 2
Coils: version C-13, see section Y
Oil temperature: -20°C + 80°C
Environment temperature: -30°C + 60°C
Recommended filtration: nominal max. 10µ, ISO 4406-19/17/14 (NAS8) or less.
 Inlet voltage fluctuations must not exceed ±10% of nominal voltage.

DIAGRAMMA PERDITE DI CARICO
 PRESSURE DROP CURVES

Valvola aperta (bobina eccitata) 2 → 1
 Valve open (energized coil) 1 → 2

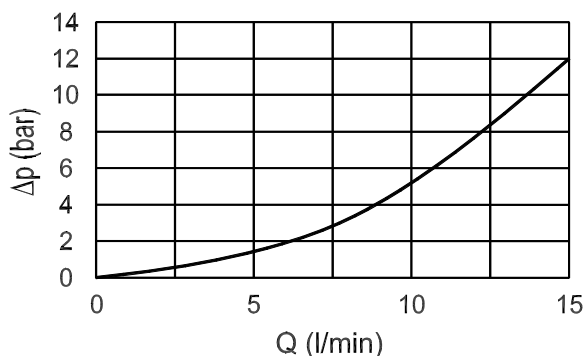

LIMITI DI FUNZIONAMENTO
 PERFORMANCE LIMITS

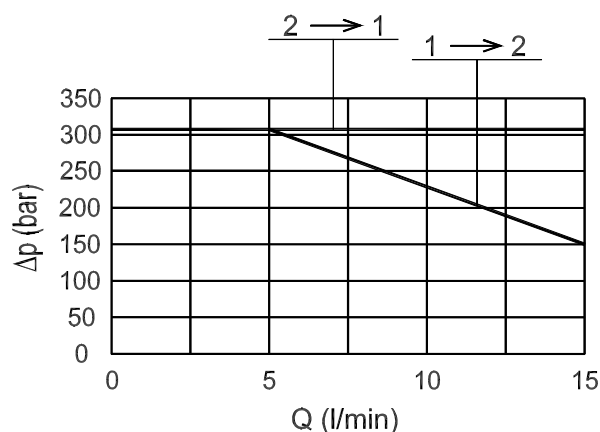

Valvola elettrica 2 vie, diretta, normalmente chiusa
2 way, direct operated electric valve, normally closed

Rev.02-2016/03

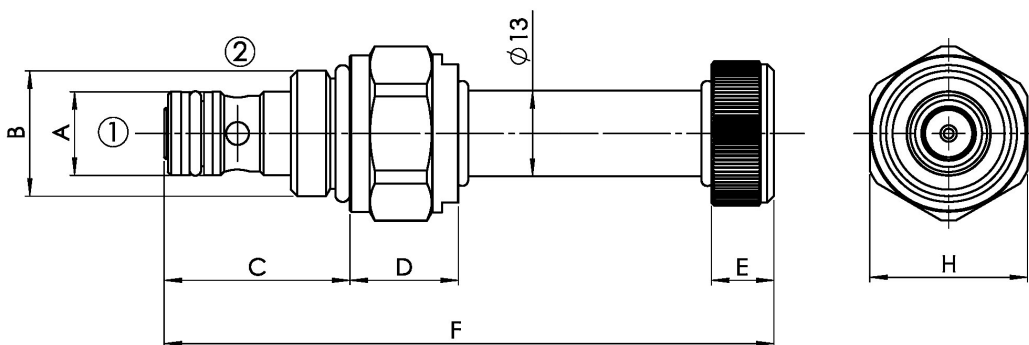

Emergenza "B" (spingi e gira)
Manual override "B" (push and twist)

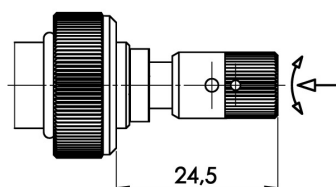

Emergenza "P" (spinta)
Manual override "P" (push)

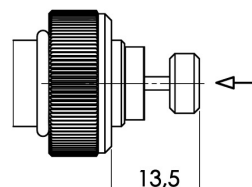

TIPO TYPE	A	B	C	D	E	F	H	CAVITA' CAVITY	COPPIA DI SERRAGGIO INSTALLATION TORQUE	PESO WEIGHT
	mm	SAE	mm	mm	mm	mm	mm		Nm	Kg
FP-22-SD-S08-04	12.7	3/4"-16 UNF-2A	27.5	16.5	9.5	92	24	23081	35 - 45	0.130
FP-22-SD-S08-04-S	12.7	3/4"-16 UNF-2A	27.5	16.5	9.5	92	24	23081	35 - 45	0.140

Per i corpi in cavità SAE a 2 vie, vedere pagina catalogo generale W 150/1
 For 2 way SAE cavity bodies, see page W 150/1 in technical catalogue

ESEMPIO DI ORDINAZIONE - ORDERING CODE EXAMPLE

FP 22 SD S08 04 * *

Guarnizioni - Seals:
 V=Viton *
 Omettere se BUNA-N - Omit if BUNA-N

Emergenza - Manual override
 P = spinta - push *
 B = spinta e giro - push and twist
 Omettere se non richiesta - Omit if not required