

## ELI2 series how to order / come ordinare

ELI	TYPE	ROTATION	DISPL.	SHAFT	PORTS	SEALS
	2	D - CW	7.0	T0	D	N
	2A	S - CCW	8.2	T1	FA**	V
	2BK1		9.6	T2		
	2BK2		11.4	C0		
	2BK4		14.0	C1		
	2BK7		16.1	C2		
			17.8	S0		
			21.0	S1		
			23.7	S2		
			25.7	S3		
			28.0	S4		
			35.0	G0		

Pump standard types		
2	= european flange + shaft T0 + ports D + standard seals	= flangia europea + albero T0 + porte D + guarnizioni standard
2A	= flange A + shaft C1 + ports FA** + standard seals	= flangia A + albero C1 + porte FA** + guarnizioni standard
2BK1	= flange BK1 + shaft T1 + ports D + standard seals	= flangia BK1 + albero T1 + porte D + guarnizioni standard
2BK2	= flange BK2 + shaft T1 + ports D + standard seals	= flangia BK2 + albero T1 + porte D + guarnizioni standard
2BK4	= flange BK4 + shaft T1 + ports D + standard seals	= flangia BK4 + albero T1 + porte D + guarnizioni standard
2BK7	= flange BK7 + shaft G0 + port D + standard seals	= flangia BK7 + albero G0 + porte D + guarnizioni standard
<b>Examples:</b>		
ELI2-D-8.2-T0-D-N	= clockwise rotation. 8.2 cm /rev. european flange. 1.8 tapered shaft. flanged ports D type. standard seals	= pompa destra. 8.2 cm /giro. flangia europea. albero conico 1.8. porte flangiate tipo D. guarnizioni standard
ELI2-D-9.6-S1-D-N	= clockwise rotation. 9.6 cm /rev. european flange splined shaft S1. flanged ports D type. standard seals	= pompa destra. 9.6 cm <sup>3</sup> /giro. flangia europea. albero scanalato S1. porte flangiate tipo D. guarnizioni standard.
ELI2A-D-11.4-S3-FA-N	= clockwise rotation. 11.4 cm /rev. SAE flange. splined shaft S3. threaded ports FA**. standard seals.	= pompa destra. 11.4 cm /giro. flangia SAE. albero scanalato S3. porte filettate tipo FA**. guarnizioni standard
ELI2BK1-S-14.0-T1-D-V	= counterclockwise rotation. 14.0 cm /rev. BK1 flange. 1.5 tapered shaft. flanged ports D type. fluorocarbon seals	= pompa sinistra. 14.0 cm /giro. flangia BK1. albero conico 1.5. porte flangiate tipo D. guarnizioni fluorocarbonato
ELI2BK7-D-16.1-G0-D-V	= clockwise rotation. 16.1 cm /rev. BK7 flange. shaft G0. flanged ports D type. fluorocarbon seals	= pompa destra. 16.1 cm /giro. flangia BK7. albero G0. porte flangiate tipo D. guarnizioni fluorocarbonato

The product data sheets show our standard model types. The synoptic tables for flanges, shafts and ports show all the possible configurations. For further details about the availability of each configuration please contact our Sales and Technical Dept. \* Value based on ISO4412 test procedure \*\* With thread ports on outlet side, a reduction of body fatigue strength may occur if the pump is working at elevated and intermittent pressures. For further details please contact our Sales and Technical Dept. we suggest to provide application specification through our PID form

Le tavole di prodotto rappresentano i tipi di pompa standard per Marzocchi Pompe. Le tavole sinottiche di flange, alberi e porte hanno lo scopo di rappresentare tutte le possibili configurazioni di prodotto. Per maggiori dettagli sulle disponibilità e condizioni di fornitura, consigliamo di interpellare il nostro ufficio tecnico - commerciale. \*Valore rilevato con procedura ISO 4412. \*\* Con porte filettate nel lato di mandata, nel caso di funzionamento a pressioni elevate e intermittenti è possibile una riduzione della resistenza a fatica del corpo. Per maggiori dettagli consigliamo di interpellare il nostro Ufficio Tecnico - Commerciale. Consigliamo di comunicare le specifiche dell'applicazione attraverso il nostro modulo PID.



## ELI2

Torque wrenches:  
Coppie di serraggio



50 ± 4 Nm

M6 screws 10 Nm  
Viti M6 10 Nm

Accessories supplied with the standard pump:  
woodruff key (code 522057), M12x1.5 hexagonal  
nut (code 523016), washer (code 523005). Stand-  
ard ports. M6 threads depth 13 mm.

Parti accessorie a corredo della pompa standard  
linguetta a disco (codice 522057), dado M12x1.5  
(codice 523016) rosetta elastica spaccata (codice  
523005) Poorte standard: filetti M6 profondità utile  
13 mm

ASPIRAZIONE  
INLET

MANDATA  
OUTLET

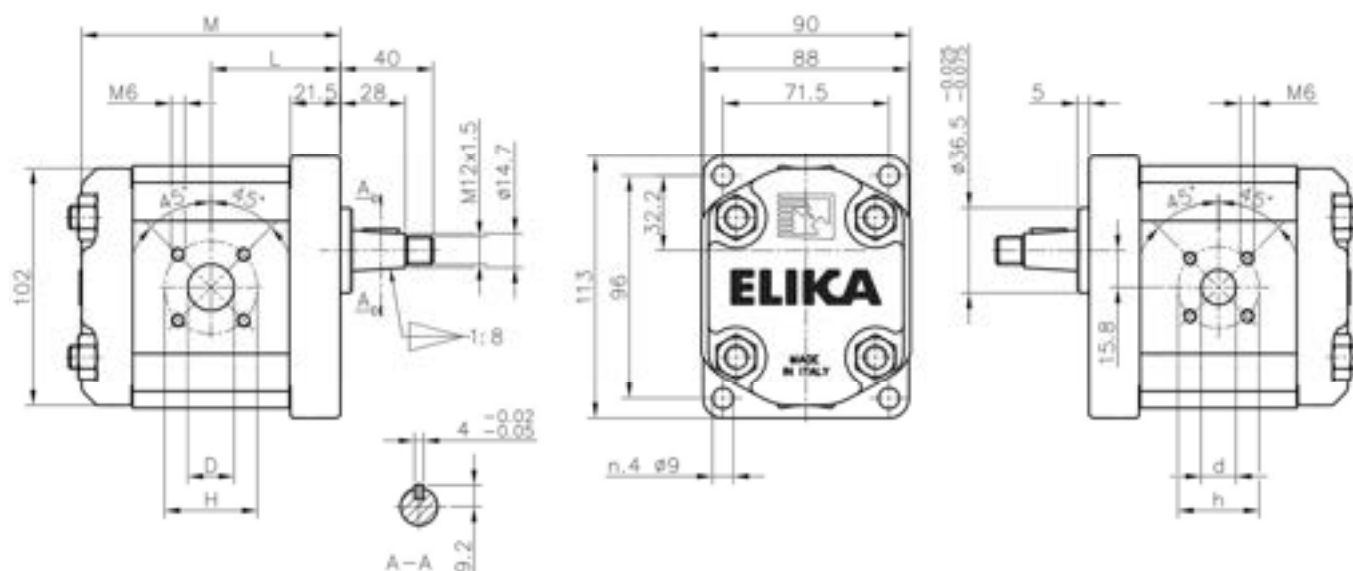

Pump Type <i>Pompa tipo</i>	Displ. <i>Cilindr.</i>	Flow at 1500 rpm <i>Portata a 1500 rpm</i>	Operating pressures <i>Pressioni operative</i>			Rotation speed <i>Velocità di rotazione</i>		Noise at 1500 rpm* <i>Rumorosità a 1500 rpm</i>		Dimensions <i>Dimensioni</i>					
			P1 Max cont.	P2 Max intermitt.	P3 Max peak	Minimum speed	Maximum speed	On recirc.	at P1	L	M	D	H	d	h
	[cm <sup>3</sup> /rev]	[l/min]	[bar]	[bar]	[bar]	[rpm]	[rpm]	[dBA]	[dBA]	[mm]	[mm]	[mm]	[mm]	[mm]	[mm]
ELI2-D-7.0	7.0	10.5	280	295	310	300	4000	47	51	48.0	96.0	15	40	15	35
ELI2-D-8.2	8.2	12.3	280	295	310	300	4000	47	52	49.0	98.0	15	40	15	35
ELI2-D-9.6	9.6	14.5	280	295	310	300	4000	48	54	50.3	100.5	15	40	15	35
ELI2-D-11.4	11.4	17.1	280	295	310	300	4000	48	55	51.8	103.5	20	40	15	35
ELI2-D-14.0	14.0	21.0	260	275	290	300	4000	49	55	54.0	106.0	20	40	15	35
ELI2-D-16.1	16.1	24.1	260	275	290	300	4000	49	56	55.8	111.5	20	40	15	35
ELI2-D-17.8	17.8	26.7	260	275	290	300	4000	49	57	57.3	114.5	20	40	15	35
ELI2-D-21.0	21.0	31.5	230	245	260	200	3500	49	57	60.0	120.0	20	40	15	35
ELI2-D-23.7	23.7	35.5	230	245	260	200	3200	50	57	62.3	124.5	20	40	15	35
ELI2-D-25.7	25.7	38.6	210	225	240	200	3000	50	57	64.0	128.0	20	40	15	35
ELI2-D-28.0	28.0	42.1	200	215	230	200	2600	50	58	66.0	132.0	20	40	15	35
ELI2-D-35.0	35.1	52.6	150	165	180	200	2200	50	58	72.0	144.0	20	40	15	35





# ELI2BK1

Torque wrenches:  
Coppie di serraggio



50 ± 4 Nm

M6 screws 10 Nm  
Viti M6 10 Nm

Accessories supplied with the standard pump:  
woodruff key (code 522055), M12x1.5 hexagonal  
nut (code 523016), washer (code 523005). Stand-  
ard ports. M6 threads depth 13 mm.

Parti accessorie a corredo della pompa standard  
linguetta a disco (codice 522055), dado M12x1.5  
(codice 523016) rosetta elastica spaccata (codice  
523005) Porte standard: filetti M6 profondità utile  
13 mm

ASPIRAZIONE  
INLET

MANDATA  
OUTLET

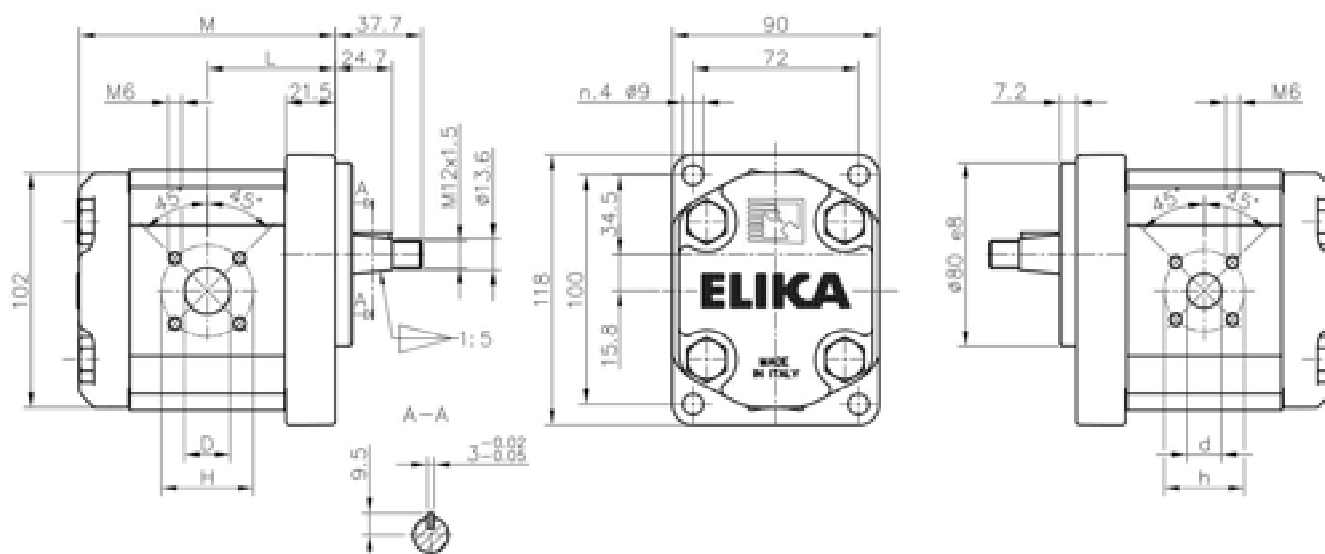

Pump Type <i>Pompa tipo</i>	Displ. <i>Cilindr.</i>	Flow at 1500 rpm <i>Portata a 1500 rpm</i>	Operating pressures <i>Pressioni operative</i>			Rotation speed <i>Velocità di rotazione</i>		Noise at 1500 rpm* <i>Rumorosità a 1500 rpm</i>		Dimensions <i>Dimensioni</i>					
			P1 Max cont.	P2 Max intermitt.	P3 Max peak	Minimum speed	Maximum speed	On recirc.	at P1	L	M	D	H	d	h
	[cm <sup>3</sup> /rev]	[l/min]	[bar]	[bar]	[bar]	[rpm]	[rpm]	[dBA]	[dBA]	[mm]	[mm]	[mm]	[mm]	[mm]	[mm]
ELI2BK1-D-7.0	7.0	10.5	280	295	310	300	4000	47	51	48.0	96.0	15	40	15	35
ELI2BK1-D-8.2	8.2	12.3	280	295	310	300	4000	47	52	49.0	98.0	15	40	15	35
ELI2BK1-D-9.6	9.6	14.5	280	295	310	300	4000	48	54	50.3	100.5	15	40	15	35
ELI2BK1-D-11.4	11.4	17.1	280	295	310	300	4000	48	55	51.8	103.5	20	40	15	35
ELI2BK1-D-14.0	14.0	21.0	260	275	290	300	4000	49	55	54.0	108.0	20	40	15	35
ELI2BK1-D-16.1	16.1	24.1	260	275	290	300	4000	49	56	55.8	111.5	20	40	15	35
ELI2BK1-D-17.8	17.8	26.7	260	275	290	300	4000	49	57	57.3	114.5	20	40	15	35
ELI2BK1-D-21.0	21.0	31.5	230	245	260	200	3500	49	57	60.0	120.0	20	40	15	35
ELI2BK1-D-23.7	23.7	35.5	230	245	260	200	3200	50	57	62.3	124.5	20	40	15	35
ELI2BK1-D-25.7	25.7	38.6	210	225	240	200	3000	50	57	64.0	128.0	20	40	15	35
ELI2BK1-D-28.0	28.0	42.1	200	215	230	200	2600	50	58	66.0	132.0	20	40	15	35
ELI2BK1-D-35.0	35.1	52.6	150	165	180	200	2200	50	58	72.0	144.0	20	40	15	35

# ELI2BK2

Accessories supplied with the standard pump: wood-ruff key (code 522055). M12x1.5 hexagonal nut (code 523016). washer (code 523005). Standard ports: M6 threads depth 13 mm

Parti accessorie a corredo della pompa: linguetta a disco (codice 522055). dado M12 x 1.5 (codice 523016). rosetta elastica spaccata (codice 523005). Porte standard: filetti M6 profondità utile 13 mm

Torque wrenches  
Coppie di serraggio



50 ± 4 Nm

M6 screws 10 Nm  
n°2 pump fixing screws  
M10 46 ± 4 Nm  
Viti M6 10 Nm  
n°2 Viti di fissaggio pompa  
M10 46 ± 4 Nm



ASPIRAZIONE  
INLET

MANDATA  
OUTLET

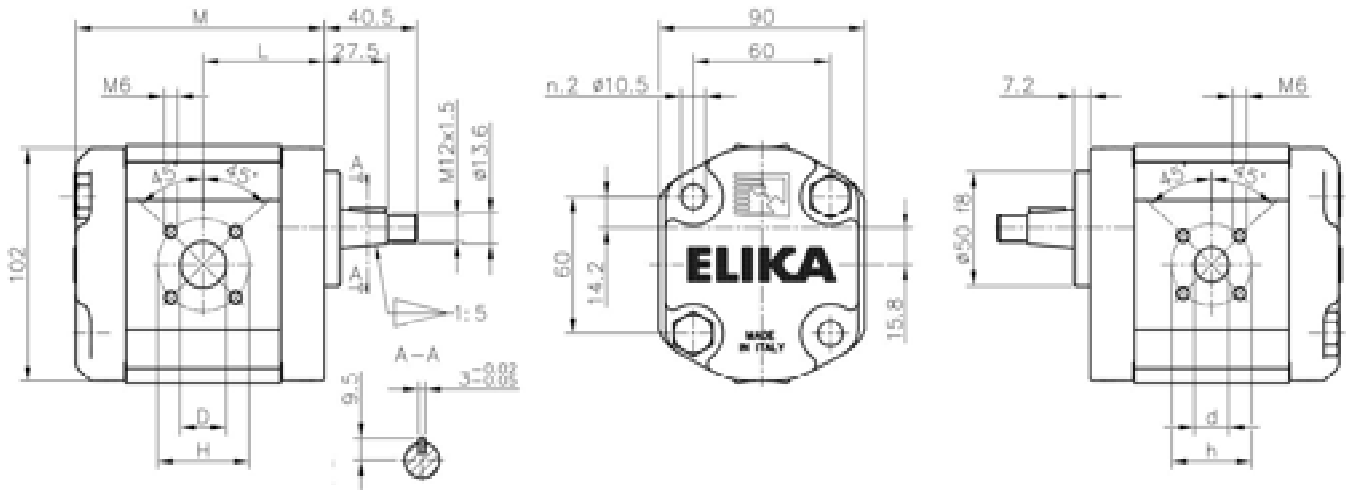

Pump Type Pompa tipo	Displ. Cilindr.	Flow at 1500 rpm Portata a 1500 rpm	Operating pressures Pressioni operative			Rotation speed Velocità di rotazione		Noise at 1500 rpm*		Dimensions Dimensioni					
			P1 Max cont.	P2 Max intermitt.	P3 Max peak	Minimum speed	Maximum speed	On recirc.	at P1	L	M	D	H	d	h
	[cm <sup>3</sup> /rev]	[l/min]	[bar]	[bar]	[bar]	[rpm]	[rpm]	[dBA]	[dBA]	[mm]	[mm]	[mm]	[mm]	[mm]	[mm]
ELI2BK2-D-7.0	7.0	10.5	280	295	310	300	4000	47	51	45.2	93.2	15	40	15	35
ELI2BK2-D-8.2	8.2	12.3	280	295	310	300	4000	47	52	46.2	95.2	15	40	15	35
ELI2BK2-D-9.6	9.6	14.5	280	295	310	300	4000	48	54	47.5	97.7	15	40	15	35
ELI2BK2-D-11.4	11.4	17.1	280	295	310	300	4000	48	55	49.0	100.7	20	40	15	35
ELI2BK2-D-14.0	14.0	21.0	260	275	290	300	4000	49	55	51.2	105.2	20	40	15	35
ELI2BK2-D-16.1	16.1	24.1	260	275	290	300	4000	49	56	53.0	108.7	20	40	15	35
ELI2BK2-D-17.8	17.8	26.7	260	275	290	300	4000	49	57	54.5	111.7	20	40	15	35
ELI2BK2-D-21.0	21.0	31.5	230	245	260	200	3500	49	57	57.2	117.2	20	40	15	35
ELI2BK2-D-23.7	23.7	35.5	230	245	260	200	3200	50	57	59.5	121.7	20	40	15	35
ELI2BK2-D-25.7	25.7	38.6	210	225	240	200	3000	50	57	61.2	125.2	20	40	15	35
ELI2BK2-D-28.0	28.0	42.1	200	215	230	200	2600	50	58	63.2	129.2	20	40	15	35
ELI2BK2-D-35.0	35.1	52.6	150	165	180	200	2200	50	58	69.2	141.2	20	40	15	35



## ELI2BK4

Torque wrenches:  
Coppie di serraggio



50 ± 4 Nm

M6 screws 10 Nm  
n°2 pump fixing screws  
M10 46 ± 4 Nm  
Viti M6 10 Nm  
n°2 Viti di fissaggio pompa  
M10 46 ± 4 Nm

Accessories supplied with the standard pump:  
woodruff key (code 522055), M12x1.5 hexagonal  
nut (code 523016), washer (code 523005). Stand-  
ard ports. M6 threads depth 13 mm.

Parti accessorie a corredo della pompa: linguetta a  
disco (codice 522055), dado M12 x 1.5 (codice  
523016), rosetta elastica spaccata (codice  
523005) Porte standard: filetti M6 profondità utile  
13 mm

ASPIRAZIONE  
INLET

MANDATA  
OUTLET

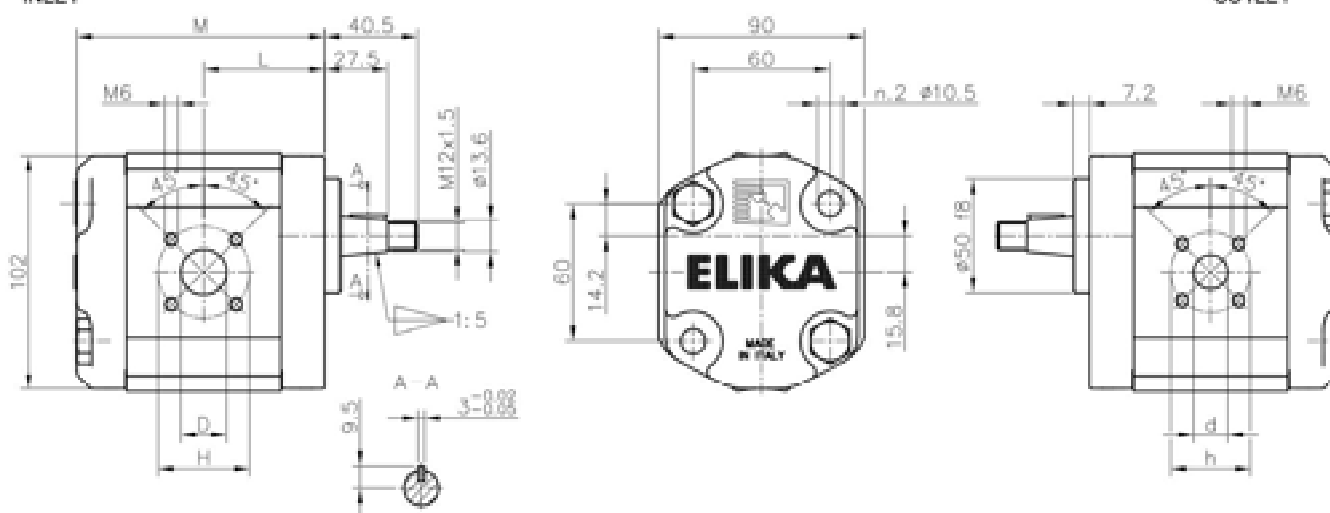

Pump Type <i>Pompa tipo</i>	Displ. <i>Cilindr.</i>	Flow at 1500 rpm <i>Portata a 1500 rpm</i>	Operating pressures <i>Pressioni operative</i>			Rotation speed <i>Velocità di rotazione</i>		Noise at 1500 rpm*		Dimensions <i>Dimensioni</i>					
			P1 Max cont.	P2 Max intermitt.	P3 Max peak	Minimum speed	Maximum speed	On recirc.	at P1	L	M	D	H	d	h
	[cm <sup>3</sup> /rev]	[l/min]	[bar]	[bar]	[bar]	[rpm]	[rpm]	[cBA]	[cBA]	[mm]	[mm]	[mm]	[mm]	[mm]	[mm]
ELI2BK4-D-7.0	7.0	10.5	280	295	310	300	4000	47	51	45.2	93.2	15	40	15	35
ELI2BK4-D-8.2	8.2	12.3	280	295	310	300	4000	47	52	46.2	95.2	15	40	15	35
ELI2BK4-D-9.6	9.6	14.5	280	295	310	300	4000	48	54	47.5	97.7	15	40	15	35
ELI2BK4-D-11.4	11.4	17.1	280	295	310	300	4000	48	55	49.0	100.7	20	40	15	35
ELI2BK4-D-14.0	14.0	21.0	260	275	290	300	4000	49	55	51.2	105.2	20	40	15	35
ELI2BK4-D-16.1	16.1	24.1	260	275	290	300	4000	49	56	53.0	108.7	20	40	15	35
ELI2BK4-D-17.8	17.8	26.7	260	275	290	300	4000	49	57	54.5	111.7	20	40	15	35
ELI2BK4-D-21.0	21.0	31.5	230	245	260	200	3500	49	57	57.2	117.2	20	40	15	35
ELI2BK4-D-23.7	23.7	35.5	230	245	260	200	3200	50	57	59.5	121.7	20	40	15	35
ELI2BK4-D-25.7	25.7	38.6	210	225	240	200	3000	50	57	61.2	125.2	20	40	15	35
ELI2BK4-D-28.0	28.0	42.1	200	215	230	200	2600	50	58	63.2	129.2	20	40	15	35
ELI2BK4-D-35.0	35.1	52.6	150	165	180	200	2200	50	58	69.2	141.2	20	40	15	35

# ELI2BK7

Standard ports. M6 threads depth 13 mm.

Torque wrenches  
Coppie di serraggio

M6 screws 10 Nm  
n°2 pump fixing screws  
M10 46 ± 4 Nm  
Viti M6 10 Nm  
n°2 Viti di fissaggio pompa  
M10 46 ± 4 Nm

Porte standard: filetti M6 profondità utile 13 mm



ASPIRAZIONE  
INLET

MANDATA  
OUTLET

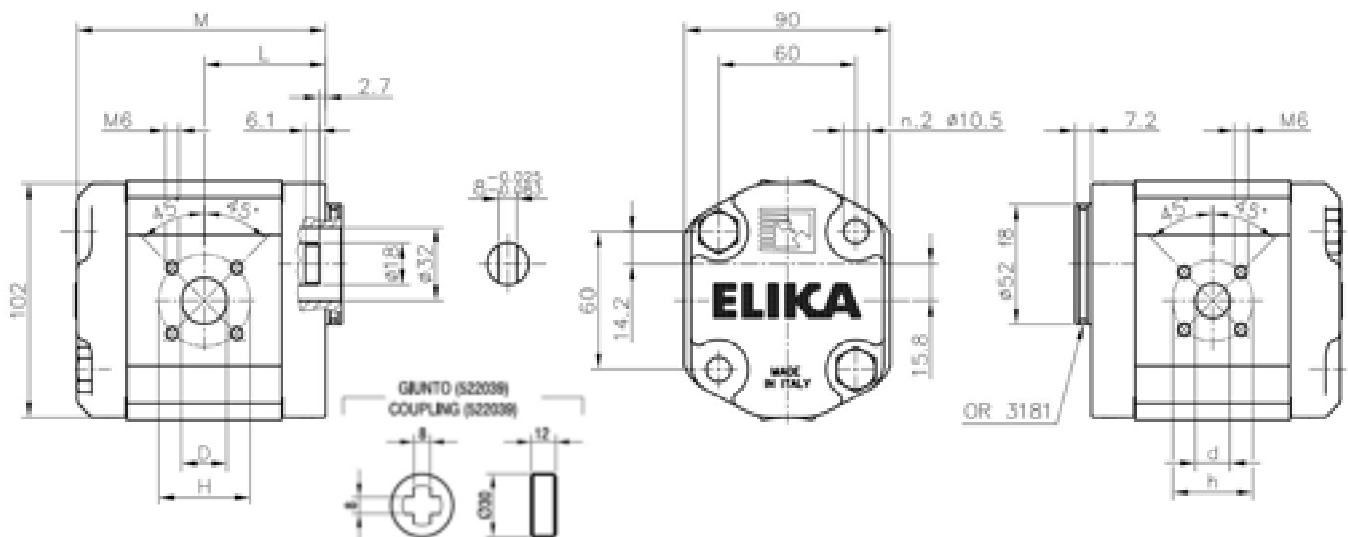

Pump Type <i>Pompa tipo</i>	Displ. <i>Cilindr.</i>	Flow at 1500 rpm <i>Portata a 1500 rpm</i>	Operating pressures <i>Pressioni operative</i>			Rotation speed <i>Velocità di rotazione</i>		Noise at 1500 rpm * <i>Rumorosità a 1500 rpm</i>		Dimensions <i>Dimensioni</i>					
			P1 Max cont.	P2 Max intermitt.	P3 Max peak	Minimum speed	Maximum speed	On recirc.	at P1	L	M	D	H	d	h
	[cm <sup>3</sup> /rev]	[l/min]	[bar]	[bar]	[bar]	[rpm]	[rpm]	[dBA]	[dBA]	[mm]	[mm]	[mm]	[mm]	[mm]	[mm]
ELI2BK7-D-7.0	7.0	10.5	280	295	310	300	4000	47	51	45.2	93.2	15	40	15	35
ELI2BK7-D-8.2	8.2	12.3	280	295	310	300	4000	47	52	46.2	96.2	15	40	15	35
ELI2BK7-D-9.6	9.6	14.5	280	295	310	300	4000	48	54	47.5	97.7	15	40	15	35
ELI2BK7-D-11.4	11.4	17.1	280	295	310	300	4000	48	55	49.0	100.7	20	40	15	35
ELI2BK7-D-14.0	14.0	21.0	260	275	290	300	4000	49	55	51.2	105.2	20	40	15	35
ELI2BK7-D-16.1	16.1	24.1	260	275	290	300	4000	49	56	53.0	108.7	20	40	15	35
ELI2BK7-D-17.8	17.8	26.7	260	275	290	300	4000	49	57	54.5	111.7	20	40	15	35
ELI2BK7-D-21.0	21.0	31.5	230	245	260	200	3500	49	57	57.2	117.2	20	40	15	35
ELI2BK7-D-23.7	23.7	35.5	230	245	260	200	3200	50	57	59.5	121.7	20	40	15	35
ELI2BK7-D-25.7	25.7	38.6	210	225	240	200	3000	50	57	61.2	125.2	20	40	15	35
ELI2BK7-D-28.0	28.0	42.1	200	215	230	200	2600	50	58	63.2	129.2	20	40	15	35
ELI2BK7-D-35.0	35.1	52.6	150	165	180	200	2200	50	58	69.2	141.2	20	40	15	35

**FLANGE / FLANGES**

**ALBERI / SHAFTS**

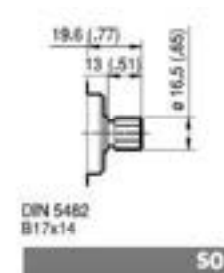
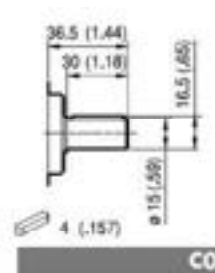
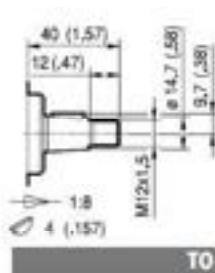
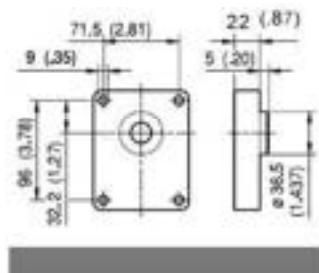

**TO**  
Coppia Max  
Max Torque **145 Nm**

**CO**  
Coppia Max  
Max Torque **125 Nm**

**SO**  
Coppia Max  
Max Torque **130 Nm**

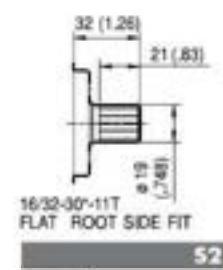
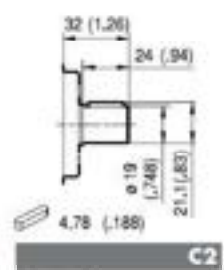
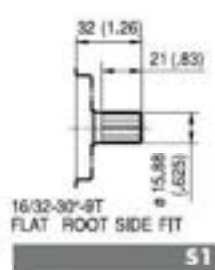
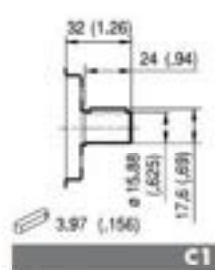
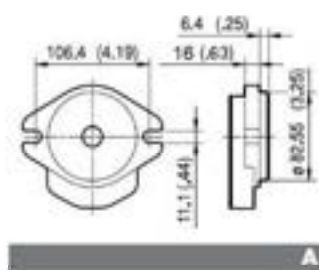

**C1**  
Coppia Max  
Max torque **105 Nm**

**S1**  
Coppia Max  
Max Torque **110 Nm**

**C2**  
Coppia Max  
Max Torque **150 Nm**

**S2**  
Coppia Max  
Max Torque **230 Nm**

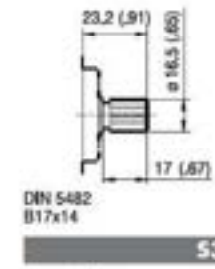
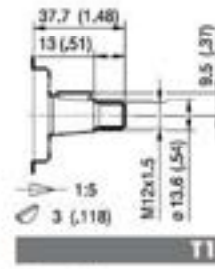
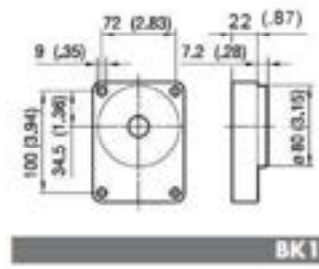

**T1**  
Coppia Max  
Max Torque **130 Nm**

**S3**  
Coppia Max  
Max Torque **130 Nm**

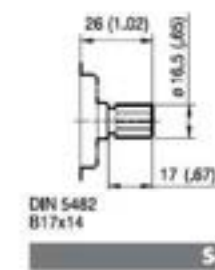
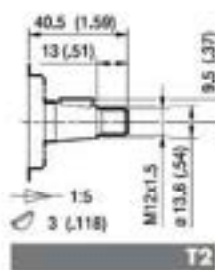
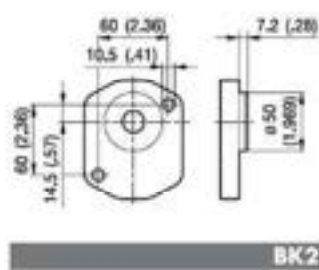

**T2**  
Coppia Max  
Max Torque **130 Nm**

**S4**  
Coppia Max  
Max Torque **130 Nm**

### FLANGE / FLANGES

### ALBERI / SHAFTS

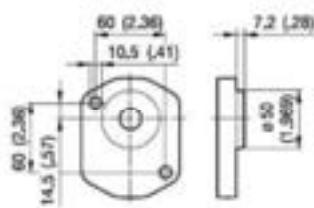

**BK4**

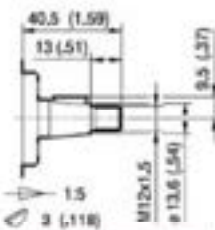

**T2**

Coppia Max  
Max Torque **130 Nm**

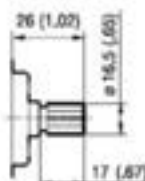

DIN 5482  
B17x14

**S4**

Coppia Max  
Max Torque **130 Nm**

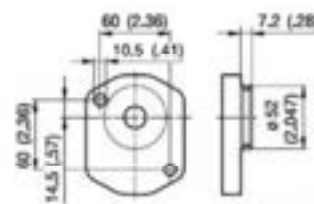

OR 3181

**BK7**

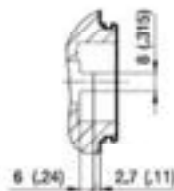

**G0**

Coppia Max  
Max Torque **105 Nm**

Maximum torque ratings are referred to ideal working conditions, such values may reduce based on the quality of joints and connections used. *Le coppie massime si riferiscono a condizioni di funzionamento ideali, i valori possono ridursi a causa della qualità dei giunti e delle connessioni impiegate.*

### PORTE / PORTS

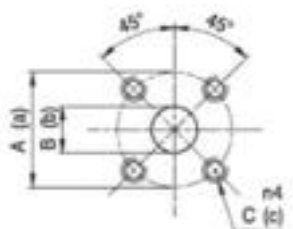

**D**

Tipo Type	Aspirazione Inlet			Mandata Outlet		
	A	B	C	a	b	c
<b>ELI 7 0 - 9 6</b>	40	15	<b>M6</b>	<b>35</b>	15	<b>M6</b>
<b>ELI 11 4- 35 0</b>	40	20	<b>M6</b>	<b>35</b>	15	<b>M6</b>

Tightening torques for M6 screws 10 Nm

*Viti M6 coppia di serraggio massima 10 Nm*



STANDARD SAE J1926/1

**FA**

Type Tipo	Aspirazione Inlet	Mandata Outlet
	<b>A</b>	<b>a</b>
<b>ELI 7.0 + 28.0</b>	<b>1 1/16-12 UNF</b>	<b>7/8-14 UNF</b>
<b>ELI 35 0</b>	<b>1 5/16-12 UNF</b>	<b>7/8-14 UNF</b>

Tightening torques for 7/8-14 UNF fitting 50 Nm Tightening torques for 1 1/16-12 UNF and 1 5/16-12 UNF fitting 60 Nm *Raccordo 7/8-14 UNF coppia di serraggio massima 50 Nm Raccordo 1 1/16-12 UNF e 1 5/16-12 UNF coppia di serraggio massima 60 Nm.*

A reduction of body fatigue strength may occur if the pump is working at elevated and intermittent pressures. *Nel caso di funzionamento a pressioni elevate e intermittenti è possibile una riduzione della resistenza a fatica del corpo.*

ELI2-7.0

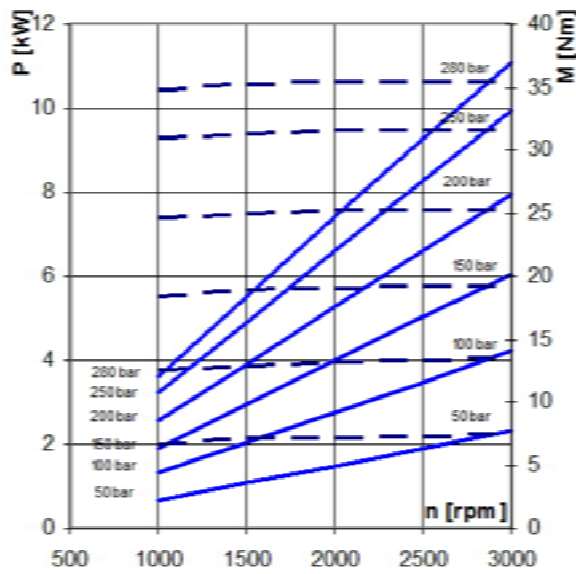

ELI2-8.2

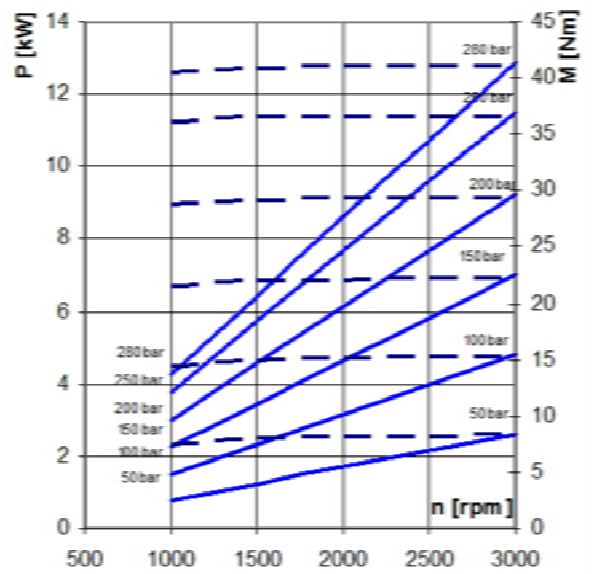

ELI2-9.6

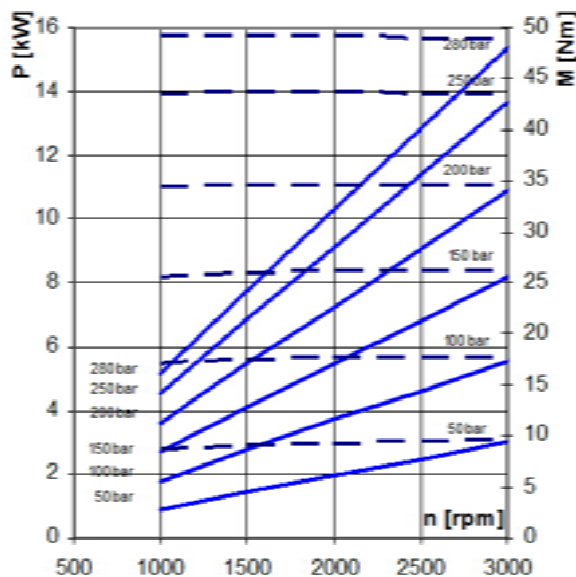

ELI2-11.4

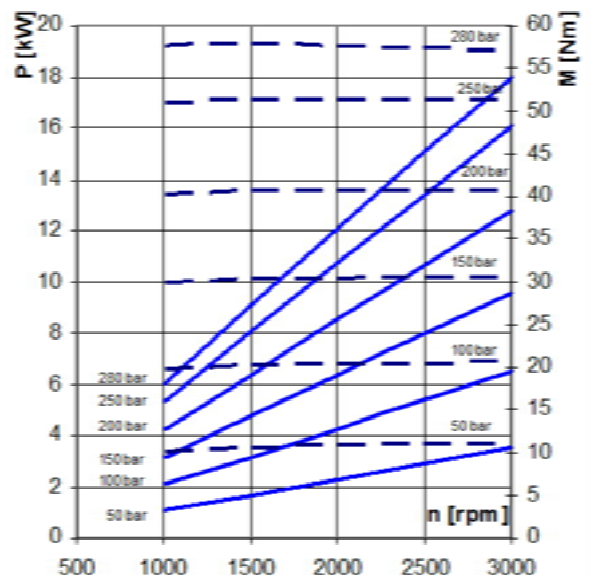

ELI2-14.0

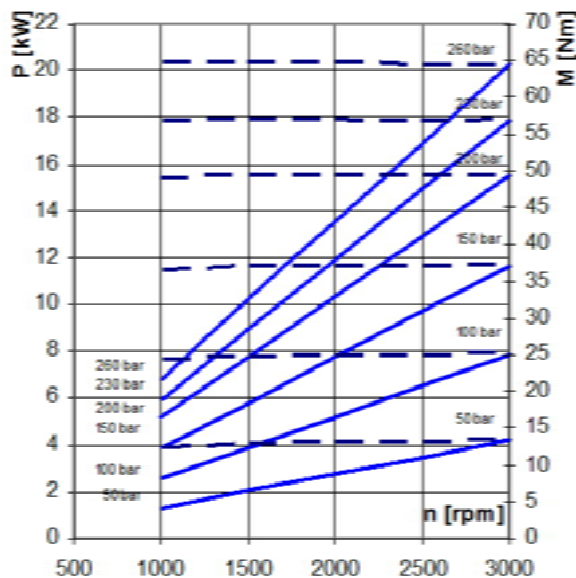

ELI2-16.1

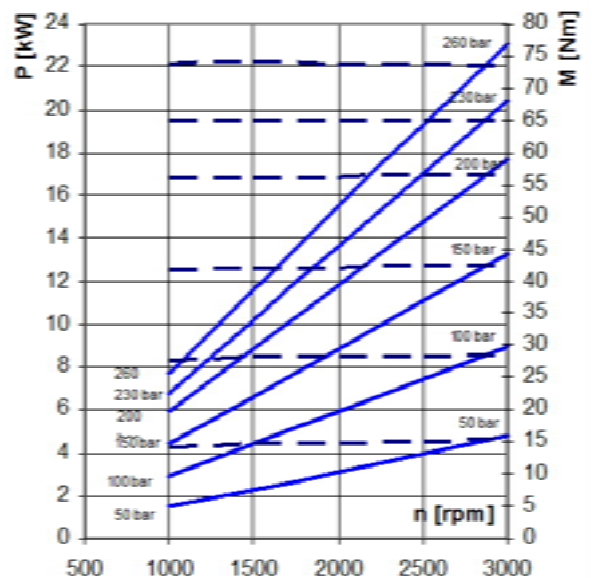

ELI2-17.8

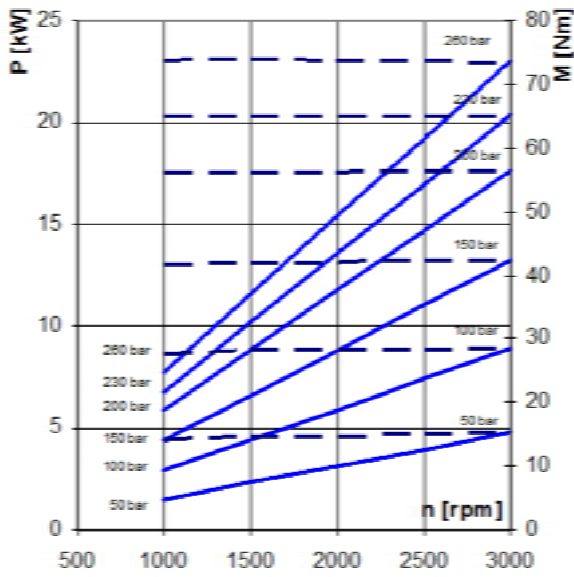

ELI2-21.0

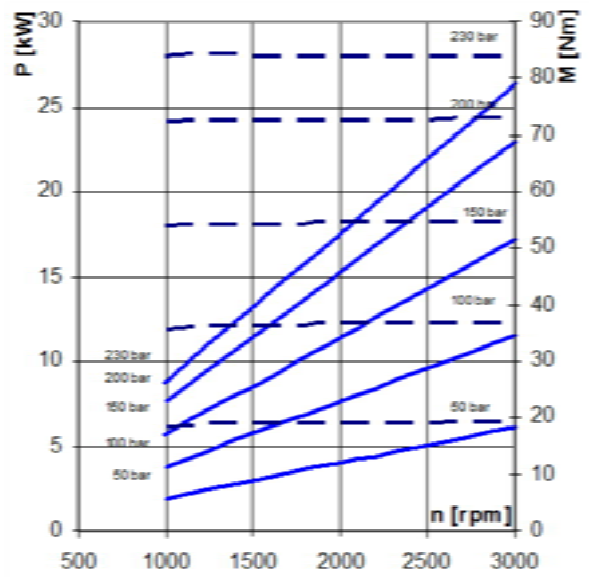

ELI2-23.7

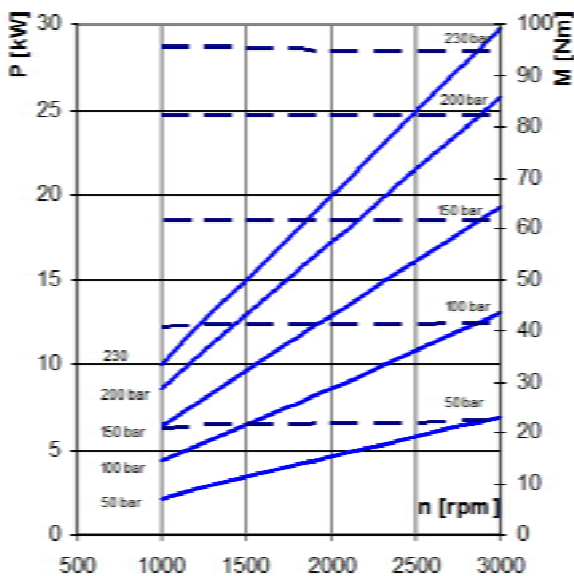

ELI2-25.7

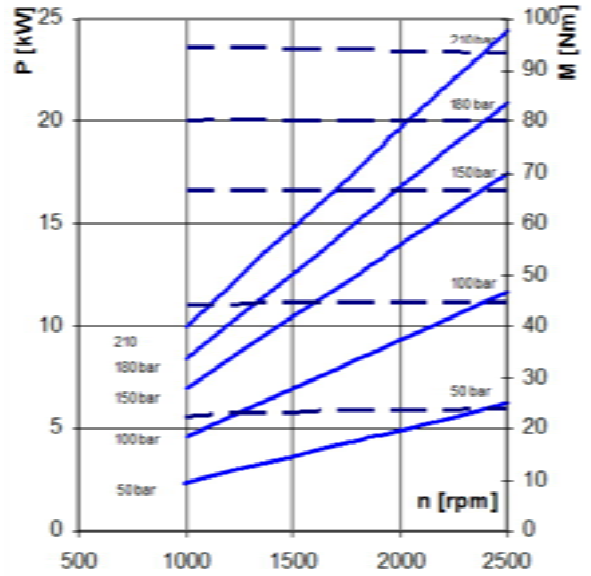

ELI2-28.0

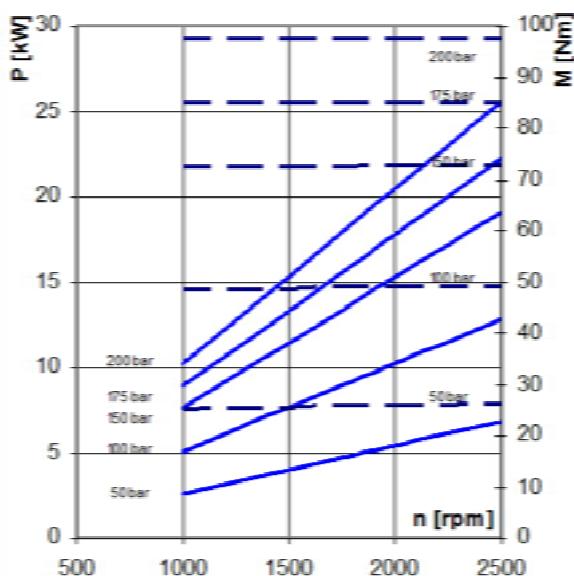

ELI2-35.0

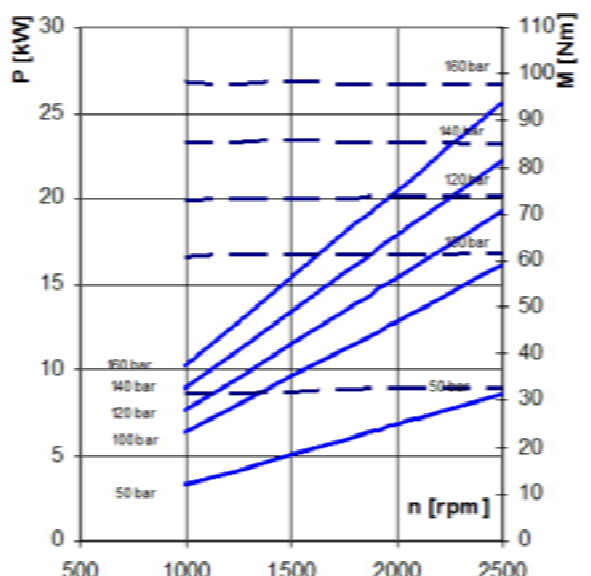

ELI2-7.0 / ELI2-8.2

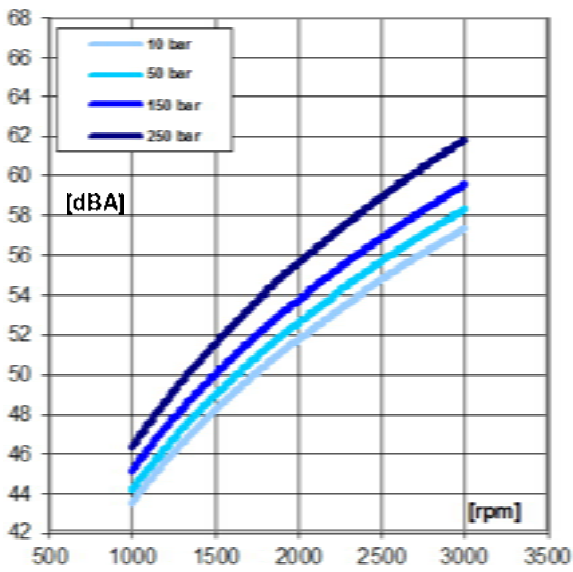

ELI2-9.6 / EU2-11.4

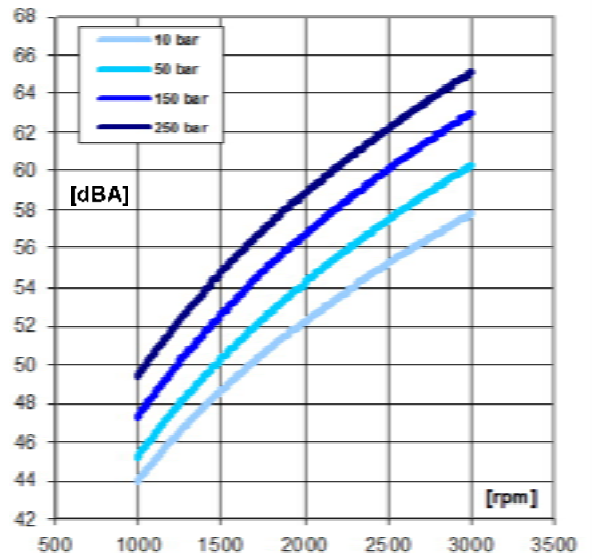

ELI2-14.0 / ELI2-16.1

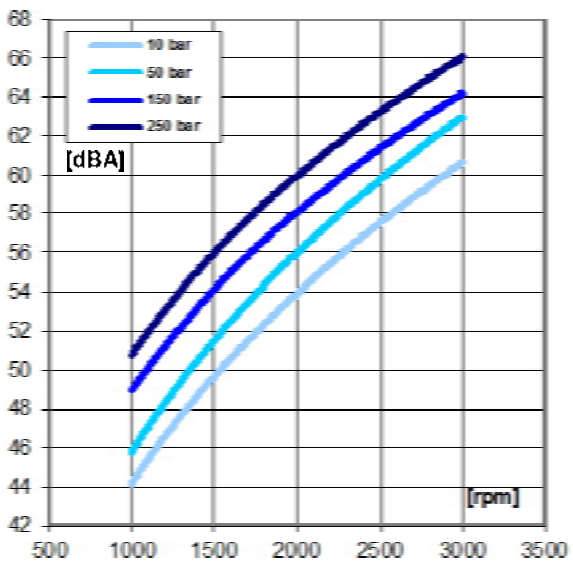

ELI2-17.8 / ELI2-21.0

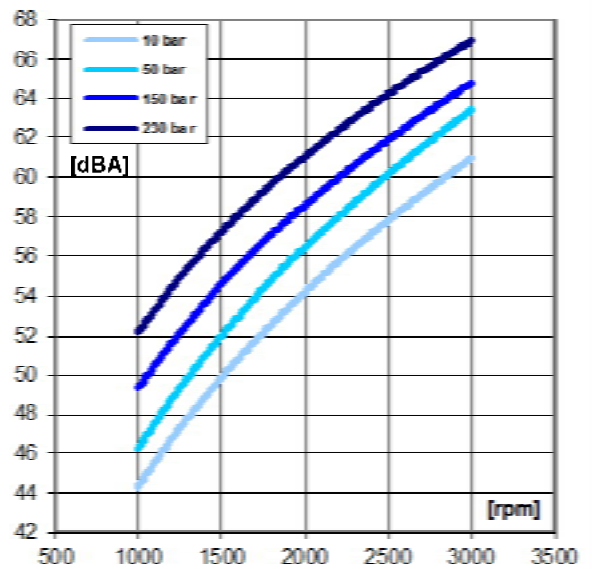

ELI2-23.7 / ELI2-25.7

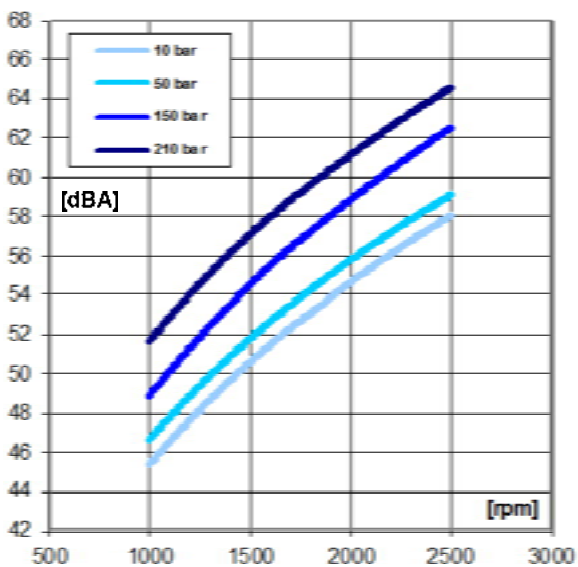

ELI2-28.0 / ELI2-35.0

